



# CHAVES PARA FECHO LINGUETA - EM POLIAMIDA

Produzidas com uma furação para fixar um anel de chaveiro. Todos os modelos podem ser produzidos com a logomarca do cliente sob encomenda.

Chaves com formato "A" usadas para fechos quarto de volta standard.

Chaves com formato "B" são usadas para fechos standard e mini.



## MATERIAL

Key: Brass

## RELATED PRODUCTS

Needed components for a complete system:  
2-070

Use the Index Code at [industriilas.com](http://industriilas.com)

## TESTS & STANDARDS

Other colours on request.

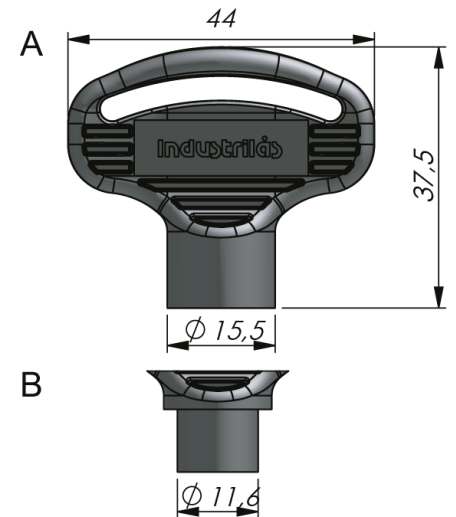
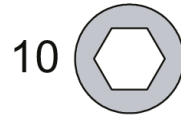
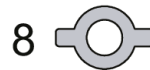
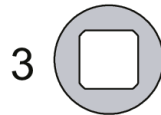
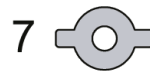
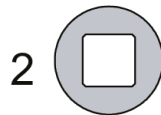
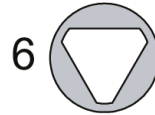
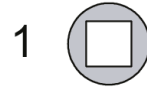

**Industriilas**  
— When access counts —

P/N	For insert	Shape	Desenho
29501001	Quadrado 6	B	1
29501002	Quadrado 7	B	2
29501003	Quadrado 8	B	3
29501004	Triângulo 6,5	B	13
29501005	Triângulo 7	A	4
29501006	Triângulo 8	A	5
29501007	Triângulo 10	A	6
29501008	Universal 3mm	A	7
29501009	Universal 5mm	A	10
29501010	Sextavado 8,5	A	10
29501011	Triangle 10 / radius	A	9
29501012	Recessed hexagon 8/3 mm pin	B	11
29501013	Quadrado rebaixado 8	A	15